

+30
YEARS



Rosette in Rosette up Connector

The finishing touch behind every fixture







psmlighting

Delighted to help you



All information in this catalogue is without engagement.
Psmighting bv reserves the right to alter materials, characteristics and dimensions without prior notice.
Read instructions carefully. The general psmighting sales conditions are always applicable.
Nothing in this catalogue can be reproduced without permission in writing from the psmighting bv company.

S1/.. - SET TORSION SPRINGS

IP20    0.0050 

supplement - set torsion springs





Ref

S1



built-in

S2/.. - SET FLAT SPRINGS

IP20    0.0090 

supplement - set flat springs

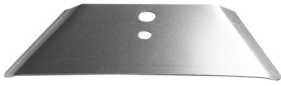

Ref

S2



built-in

029/.. - STEELCABLE HOLDER

IP20    



accessories for lighting systems - steelcable holder

Dimensions

↔ Ø20xH48 mm

Materials

Aluminium 2M | 14

Ref

029.2M



029.14



built-up

031/.. - STEELCABLE HOLDER

IP20    



accessories for lighting systems - steelcable holder

Dimensions

↔ Ø16xH34 mm

Materials

Aluminium 2M | 14

Ref

031.2M



031.14



051/.. - STEEL CABLE HOLDER

IP20    



accessories for lighting systems - Steelcable holder with side exit suitable for cable Ø1.00 to Ømm

Dimensions

↔ Ø16xH34 mm

Materials





Aluminium 2M

Ref

051.2M



P038/.. - STRAIN RELIEF - TREKONTLASTING

IP20    



Accessories for pendant lamps - strain relief for cable Ø3mm

Dimensions

↔ Ø12xH20 mm

Materials





Aluminium 1M | 2M

Ref

- P038.1M 
- P038.2M 

built-up
to be fixed to rosette or ceiling base
for cable KX and K

P039/.. - STRAIN RELIEF - TREKONTLASTING

IP20    



Accessories for pendant lamps - strain relief for cable max. Ø6.5 mm















Dimensions

↔ Ø15xH20 mm

Materials





Aluminium 1 | 1M | 2 | 2M | 14 | 11 | 44 | 53 | 46 | 21
 Messing 4 | 16 | 13 | 23
 Rood koper 28

Ref

- P039.1 
- P039.1M 
- P039.2 
- P039.2M 
- P039.14 
- P039.11 
- P039.44 
- P039.4 
- P039.16 
- P039.13 
- P039.23 
- P039.53 
- P039.46 
- P039.28 
- P039.21 

built-up
to be fixed to rosette or ceiling base

P040/.. - STRAIN RELIEF - TREKONTLASTING

IP20    



Accessories for pendant lamps - strain relief for cable max. Ø6.5 mm











Dimensions

↔ Ø15xH20 mm

Materials

Aluminium 1 | 1M | 2 | 2M | 14 | 11
 Messing 4 | 16 | 13 | 23
 Rood koper 28

Ref

- P040.1 
- P040.1M 
- P040.2 
- P040.2M 
- P040.14 
- P040.11 
- P040.4 
- P040.16 
- P040.13 
- P040.23 
- P040.28 

built-up
to be fixed to rosette or ceiling base



1791/.. - STRAIN RELIEF - TREKONTLASTING

IP20  



Accessories for pendant lamps - strain relief for cable max. Ø6.5 mm

Dimensions

↔ Ø15xH20 mm

Materials

Aluminium 1M | 2M



Ref

1791.1M 

1791.2M 

built-up

1113/.. - STRAIN RELIEF - TREKONTLASTING

IP20     

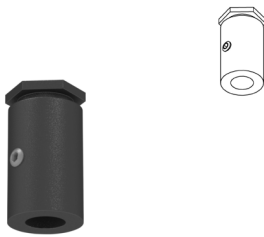

Accessories for pendant lamps - strain relief for cable 4x

Dimensions

↔ Ø16xH21 mm

Materials

Aluminium 1 | 1M | 2 | 2M | 14 | 11 | 119

Ref

1113.1 

1113.1M 

1113.2 

1113.2M 

1113.14 

1113.11 

1113.119 

to be fixed to rosette or ceiling base for cables: 3x1.5 and TXL leather



056/.. - DECENTRALISATIESTEUN

IP20    0.0456 



built-up
for textile kabel 3x

Accessories for pendant lamps - cable conduit support for suspension lights

Dimensions

↔ Ø19xH38 mm

Materials

Aluminium 1M | 2M | 14
Messing 16 | 13 | 23

Ref

056.1M
056.2M
056.14
056.16
056.13
056.23



1651/.. - DECENTRALISATIESTEUN

IP20    0.0300 



built-up
for textile kabel 3x

Cable entry support / decentralization kit for pendant lights with fine cable Ø3 mm

Dimensions

↔ Ø12xH26,5 mm

Materials





Aluminium 1M | 2M | 119

Ref

1651.1M
1651.2M



1069/.. - SUPPORT FOR TEXTILE CABLE

IP20    0.0467 



built-up

Accessories for pendant lamps - cable conduit support for suspension lights

Dimensions

↔ Ø20xH30 mm

Materials





Aluminium 1M | 2M | 53 | 46

Ref

1069.1M
1069.2M
1069.53
1069.46



5014/.. - MAESTRO

IP20    0.0400 



built-up

Accessories for pendant lamps - connector for wall or ceiling cord attachment for iron cord

Dimensions

↔ Ø20xH14 mm

Materials

Aluminium 1M | 2M
Messing 16 | 13 | 23

Ref

5014.1M
5014.2M
5014.16
5014.13
5014.23



023.M6/.. - CONNECTOR FOR TRACKS

IP20    CE



acces. for built-up spot or pendant - M10 - M6x1 (12V)







Dimensions

↔ Ø14xH30 mm

Materials

Aluminium 1 | 2 | 14 | 11
Messing 4 | 16 | 13

Ref

023.M6.1	
023.M6.2	
023.M6.4	
023.M6.11	
023.M6.13	
023.M6.14	
023.M6.16	

023.M10/.. - CONNECTOR FOR TRACKS

IP20    CE



acces. for built-up spot or pendant - M10 - M8x (12V)









Dimensions

↔ Ø14xH30 mm

Materials

Aluminium 1 | 2 | 2M | 14 | 11
Messing 4 | 16 | 13

Ref

023.M10.1	
023.M10.2	
023.M10.2M	
023.M10.4	
023.M10.11	
023.M10.13	
023.M10.14	
023.M10.16	

024/.. - CONNECTOR FOR TRACKS

IP20    CE











acces. for built-up spot or pendant - for monorail M10x1 - M8x (12V-230V)

Materials

Aluminium 1 | 1M | 2 | 2M | 14 | 11
Messing 4 | 16 | 13

Ref

024.1	
024.1M	
024.2	
024.2M	
024.4	
024.11	
024.13	
024.14	
024.16	

built-up

2121.2/.. - ROSETTE IN

S1 IP20    0.1773 



rosette to build in - round - with strain reliefs for 2 textile cables

Dimensions





↔ Ø100 mm  Ø80 mm

⊥ 55 mm

Materials

Aluminium 1M | 2M | 117 | 118 | 119

Ref

- 2121.2.1M 
- 2121.2.2M 
- 2121.2.117 
- 2121.2.118 
- 2121.2.119 

built-in

2121.3/.. - ROSETTE IN

S1 IP20    0.1773 



rosette to build in - round - with strain reliefs for 3 textile cables

Dimensions

↔ Ø100 mm  Ø100 mm

⊥ 55 mm

Materials

Aluminium 1M | 2M | 117 | 118 | 119

Ref

- 2121.3.1M 
- 2121.3.2M 
- 2121.3.117 
- 2121.3.118 
- 2121.3.119 

built-in

2121.5/.. - ROSETTE IN

S1 IP20    0.1773 

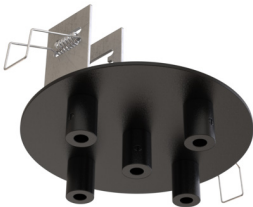

rosette to build in - round - with strain reliefs for 5 textile cables

Dimensions





↔ Ø120 mm  Ø100 mm

⊥ 55 mm

Materials

Aluminium 1M | 2M | 117 | 118 | 119

Ref

- 2121.5.1M 
- 2121.5.2M 
- 2121.5.117 
- 2121.5.118 
- 2121.5.119 

built-in

2121.7/.. - ROSETTE IN

S1 IP20    0.1773 



rosette to build in - round - with strain reliefs for 7 textile cables

Dimensions





↔ Ø120 mm  Ø100 mm

⊥ 55 mm

Materials

Aluminium 1M | 2M | 117 | 118 | 119















Ref

- 2121.7.1M 
- 2121.7.2M 
- 2121.7.117 
- 2121.7.118 
- 2121.7.119 

built-in















013/.. - ROSETTE IN

S1 IP20    0.0232 

<i>built-in</i>			rosette to build in - round	Ref		
			Dimensions	013.1		
			 Ø33 mm	 Ø30 mm	013.1M	
			 L 45 mm	013.2		
			Materials	013.2M		
			Aluminium	1 1M 2 2M 14 11	013.14	
			Inox 304	5	013.11	
			Messing	4 16 13	013.5	
			Options	013.4		
			P040/.. STRAIN RELIEF - TREKONTLASTING	013.16		
			P039/.. STRAIN RELIEF - TREKONTLASTING	013.13		
			P038/.. STRAIN RELIEF - TREKONTLASTING			

















014/.. - ROSETTE IN

S1 IP20    0.0248 

<i>built-in</i>			rosette to build in - round	Ref		
			Dimensions	014.1		
			 Ø43 mm	 Ø39-40 mm	014.1M	
			 L 45 mm	014.2		
			Materials	014.2M		
			Aluminium	1 1M 2 2M 14 11	014.14	
			Inox 316	5	014.11	
			Messing	4 16 13	014.5	
			Options	014.4		
			P040/.. STRAIN RELIEF - TREKONTLASTING	014.16		
			P039/.. STRAIN RELIEF - TREKONTLASTING	014.13		
			P038/.. STRAIN RELIEF - TREKONTLASTING			

002/.. - ROSETTE IN

S1 IP20    0.0519 

<i>built-in</i>			rosette to build in - round	Ref		
			Dimensions	002.1		
			 Ø50 mm	 Ø35-40 mm	002.1M	
			 L 45 mm	002.2		
			Materials	002.2M		
			Aluminium	1 1M 2 2M 14 11 119	002.14	
			Inox 316	5	002.11	
			Messing	4 16 13 13M	002.5	
			Options	002.4		
			S2/.. SET FLAT SPRINGS	002.16		
			P040/.. STRAIN RELIEF - TREKONTLASTING	002.13		
			P039/.. STRAIN RELIEF - TREKONTLASTING	002.13M		
P038/.. STRAIN RELIEF - TREKONTLASTING	002.119					



ACCESSORIES

ROSETTE IN



61.10/.. - ROSETTE IN

S1 IP20    0.0737 



built-in



rosette to build in - round

Dimensions

↔ Ø60 mm

 Ø40 mm

⊥ 55 mm

Materials

Aluminium 1 | 1M | 2 | 2M | 14 | 11

Inox 316 5

Messing 4 | 16 | 13

Options

S2/.. SET FLAT SPRINGS

P040/.. STRAIN RELIEF - TREKONTLASTING

P039/.. STRAIN RELIEF - TREKONTLASTING

P038/.. STRAIN RELIEF - TREKONTLASTING

Ref

61.10.1

61.10.1M

61.10.2

61.10.2M

61.10.14

61.10.11

61.10.5

61.10.4

61.10.16

61.10.13



71.10/.. - ROSETTE IN

S1 IP20    0.0900 



built-in

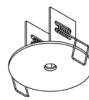

rosette to build in - round

Dimensions

↔ Ø70 mm

 Ø50 mm

⊥ 55 mm

Materials

Aluminium 1M | 2M

Options

S2/.. SET FLAT SPRINGS

P040/.. STRAIN RELIEF - TREKONTLASTING

P039/.. STRAIN RELIEF - TREKONTLASTING

P038/.. STRAIN RELIEF - TREKONTLASTING

Ref

71.10.1M

71.10.2M



81.10/.. - ROSETTE IN

S1 IP20    0.1011 

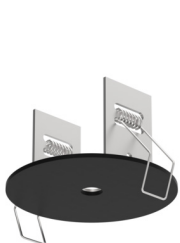

built-in



rosette to build in - round

Dimensions

↔ Ø80 mm

 Ø60 mm

⊥ 55 mm

Materials

Aluminium 1 | 1M | 2 | 2M | 14 | 11

Inox 316 5

Messing 4 | 16 | 13 | 23

Options

S2/.. SET FLAT SPRINGS

P040/.. STRAIN RELIEF - TREKONTLASTING

P039/.. STRAIN RELIEF - TREKONTLASTING

P038/.. STRAIN RELIEF - TREKONTLASTING

Ref

81.10.1

81.10.1M

81.10.2

81.10.2M

81.10.14

81.10.11

81.10.5

81.10.4

81.10.16

81.10.13

81.10.23



91.10/.. - ROSETTE IN

S1 IP20    0.1267 

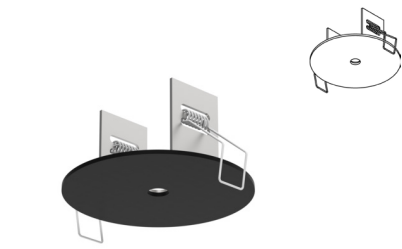

built-in

rosette to build in - round

Dimensions

→ Ø90 mm  Ø60 mm
 ↙ ↘ L 55 mm

Materials

Aluminium 1M | 2M

Options

S2/.. SET FLAT SPRINGS
 P040/.. STRAIN RELIEF - TREKONTLASTING
 P039/.. STRAIN RELIEF - TREKONTLASTING
 P038/.. STRAIN RELIEF - TREKONTLASTING

Ref

91.10.1M 
 91.10.2M 

101.10/.. - ROSETTE IN

S1 IP20    0.1863 

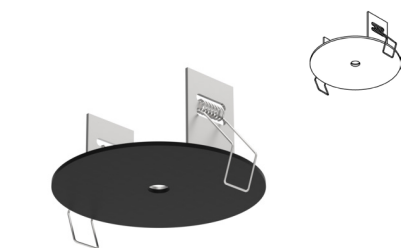

built-in

rosette to build in - round

Dimensions

→ Ø100 mm  Ø80 mm
 ↙ ↘ L 55 mm









Materials

Aluminium 1 | 1M | 2 | 2M | 14 | 11
 Messing 4 | 16 | 13

Options

S2/.. SET FLAT SPRINGS
 P040/.. STRAIN RELIEF - TREKONTLASTING
 P039/.. STRAIN RELIEF - TREKONTLASTING
 P038/.. STRAIN RELIEF - TREKONTLASTING

Ref

101.10.1 
 101.10.1M 
 101.10.2 
 101.10.2M 
 101.10.14 
 101.10.11 
 101.10.4 
 101.10.16 
 101.10.13 

121.10/.. - ROSETTE IN

S1 IP20    0.1773 

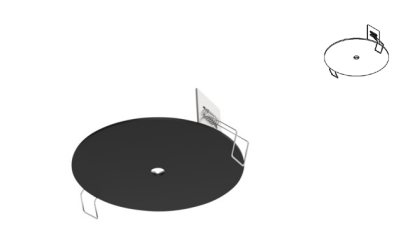

built-in

rosette to build in - round

Dimensions

→ Ø120 mm  Ø100 mm
 ↙ ↘ L 55 mm









Materials

Aluminium 1 | 1M | 2 | 2M | 14 | 11
 Messing 4 | 16 | 13

Options

S2/.. SET FLAT SPRINGS
 P040/.. STRAIN RELIEF - TREKONTLASTING
 P039/.. STRAIN RELIEF - TREKONTLASTING
 P038/.. STRAIN RELIEF - TREKONTLASTING

Ref

121.10.1 
 121.10.1M 
 121.10.2 
 121.10.2M 
 121.10.4 
 121.10.11 
 121.10.13 
 121.10.14 
 121.10.16 

141.10/.. - ROSETTE IN

S1 IP20    0.2313 

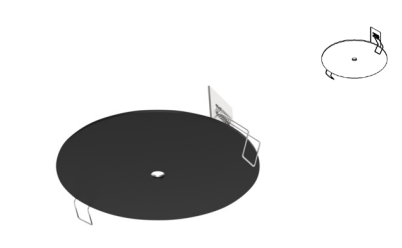

built-in

rosette to build in - round

Dimensions

→ Ø140 mm  Ø120 mm
 ↙ ↘ L 55 mm









Materials

Aluminium 1 | 1M | 2 | 2M | 14 | 11
 Messing 4 | 16 | 13

Options

S2/.. SET FLAT SPRINGS
 P040/.. STRAIN RELIEF - TREKONTLASTING
 P039/.. STRAIN RELIEF - TREKONTLASTING
 P038/.. STRAIN RELIEF - TREKONTLASTING

Ref

141.10.1 
 141.10.1M 
 141.10.2 
 141.10.2M 
 141.10.4 
 141.10.11 
 141.10.13 
 141.10.14 
 141.10.16 

161.10/.. - ROSETTE IN

S1 IP20    0.2958 

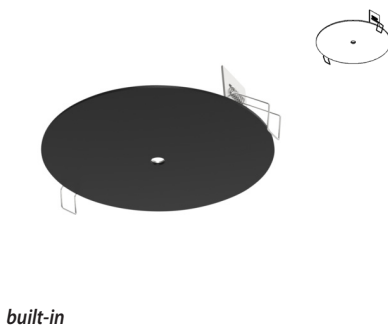

built-in

rosette to build in - round

Dimensions

↔ Ø160 mm  Ø140 mm

⊥ 55 mm









Materials

Aluminium 1 | 1M | 2 | 2M | 14 | 11
Messing 4 | 16 | 13

Options

S2/.. SET FLAT SPRINGS
P040/.. STRAIN RELIEF - TREKONTLASTING
P039/.. STRAIN RELIEF - TREKONTLASTING
P038/.. STRAIN RELIEF - TREKONTLASTING

Ref

- 161.10.1 
- 161.10.1M 
- 161.10.2 
- 161.10.2M 
- 161.10.14 
- 161.10.11 
- 161.10.4 
- 161.10.16 
- 161.10.13 

181.10/.. - ROSETTE IN

S1 IP20    0.3558 

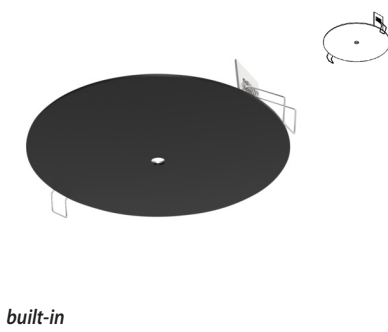

built-in

rosette to build in - round

Dimensions

↔ Ø180 mm  Ø160 mm

⊥ 55 mm









Materials

Aluminium 1 | 1M | 2 | 2M | 14 | 11
Messing 4 | 16 | 13

Options

S2/.. SET FLAT SPRINGS
P040/.. STRAIN RELIEF - TREKONTLASTING
P039/.. STRAIN RELIEF - TREKONTLASTING
P038/.. STRAIN RELIEF - TREKONTLASTING

Ref

- 181.10.1 
- 181.10.1M 
- 181.10.2 
- 181.10.2M 
- 181.10.4 
- 181.10.11 
- 181.10.13 
- 181.10.14 
- 181.10.16 



102.10/.. - ROSETTE IN

S1 IP20    0.1377 

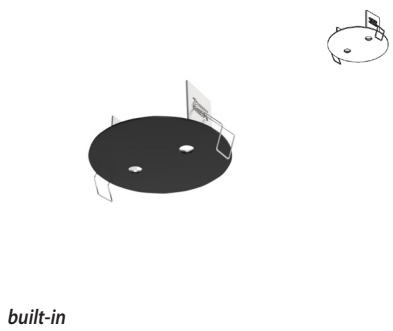

rosette to build in - round

Dimensions

→ Ø100 mm  Ø80 mm

└─┘ 55 mm

Materials

Aluminium 1 | 1M | 2 | 2M | 14 | 11

Messing 4 | 16 | 13

Options

S2/..	SET FLAT SPRINGS	102.10.1	
P040/..	STRAIN RELIEF - TREKONTLASTING	102.10.1M	
P039/..	STRAIN RELIEF - TREKONTLASTING	102.10.2	
P038/..	STRAIN RELIEF - TREKONTLASTING	102.10.2M	
		102.10.14	
		102.10.11	
		102.10.4	
		102.10.16	
		102.10.13	

Ref

built-in

122.10/.. - ROSETTE IN

S1 IP20    0.3533 

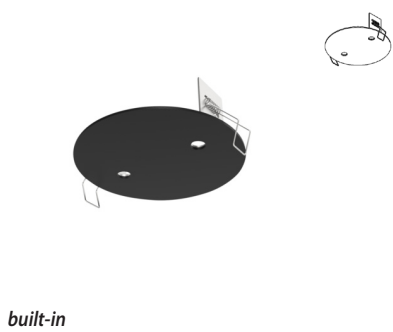

rosette to build in - round

Dimensions

→ Ø120 mm  Ø100 mm

└─┘ 55 mm

Materials

Aluminium 1 | 1M | 2 | 2M | 14 | 11

Messing 4 | 16 | 13

Options

S2/..	SET FLAT SPRINGS	122.10.1	
P040/..	STRAIN RELIEF - TREKONTLASTING	122.10.1M	
P039/..	STRAIN RELIEF - TREKONTLASTING	122.10.2	
P038/..	STRAIN RELIEF - TREKONTLASTING	122.10.2M	
		122.10.4	
		122.10.11	
		122.10.13	
		122.10.14	
		122.10.16	

Ref

built-in

142.10/.. - ROSETTE IN

S1 IP20    0.2505 

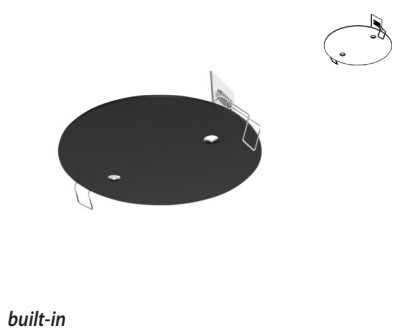

rosette to build in - round

Dimensions

→ Ø140 mm  Ø120 mm

└─┘ 55 mm

Materials

Aluminium 1 | 1M | 2 | 2M | 14 | 11

Messing 4 | 16 | 13

Options

S2/..	SET FLAT SPRINGS	142.10.1	
P040/..	STRAIN RELIEF - TREKONTLASTING	142.10.1M	
P039/..	STRAIN RELIEF - TREKONTLASTING	142.10.2	
P038/..	STRAIN RELIEF - TREKONTLASTING	142.10.2M	
		142.10.4	
		142.10.11	
		142.10.13	
		142.10.14	
		142.10.16	

Ref

built-in

162.10/.. - ROSETTE IN

S1 IP20    0.2905 

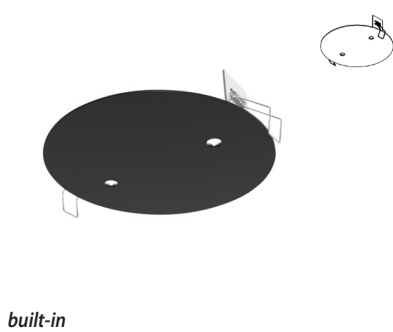

rosette to build in - round

Dimensions

→ Ø160 mm  Ø140 mm

└─┘ 55 mm

Materials

Aluminium 1 | 1M | 2 | 2M | 14 | 11

Messing 4 | 16 | 13

Options

S2/..	SET FLAT SPRINGS	162.10.1	
P040/..	STRAIN RELIEF - TREKONTLASTING	162.10.1M	
P039/..	STRAIN RELIEF - TREKONTLASTING	162.10.2	
P038/..	STRAIN RELIEF - TREKONTLASTING	162.10.2M	
		162.10.4	
		162.10.11	
		162.10.13	
		162.10.14	
		162.10.16	

Ref

built-in

182.10/.. - ROSETTE IN

S1 IP20    0.4260 

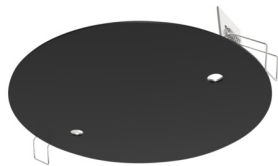

built-in



rosette to build in - round

Dimensions

↔ Ø180 mm

 Ø160 mm

⊥ 55 mm

Materials

Aluminium

1 | 1M | 2 | 2M | 14 | 11

Messing

4 | 16 | 13

Options

S2/..

SET FLAT SPRINGS

P040/..

STRAIN RELIEF - TREKONTLASTING

P039/..

STRAIN RELIEF - TREKONTLASTING

P038/..

STRAIN RELIEF - TREKONTLASTING

Ref

182.10.1

182.10.1M

182.10.2

182.10.2M

182.10.4

182.10.11

182.10.13

182.10.14

182.10.16



1693/.. - REZA

S1 IP20    



rosette to build in - round - fixed - for surface-mounted spotlight with torsion springs

Dimensions

↔ Ø52xH75 mm  Ø44 mm

⌊ L 42 mm

Materials

Aluminium 1M | 2M

Options

S2/.. SET FLAT SPRINGS

Ref

1693.1M 

1693.2M 

built-in

1694/.. - MARIE

S1 IP20    



rosette to build in - round - fixed - for surface-mounted spotlight with torsion springs

Dimensions

↔ Ø52xH75 mm  Ø44 mm

⌊ L 42 mm

Materials

Aluminium 1M | 2M

Options

S2/.. SET FLAT SPRINGS

Ref

1694.1M 

1694.2M 

built-in

1689/.. - REZA MAXI

S1 IP20    



rosette to build in - round - fixed - for surface-mounted spotlight with torsion springs

Dimensions

↔ Ø64xH38 mm  Ø52 mm

⌊ L 34 mm

Materials

Aluminium 1M | 2M

Options

S2/.. SET FLAT SPRINGS
 P040/.. STRAIN RELIEF - TREKONTLASTING
 P039/.. STRAIN RELIEF - TREKONTLASTING
 P038/.. STRAIN RELIEF - TREKONTLASTING

Ref

1689.1M 

1689.2M 

built-in



1695/.. - REZA

S1 IP20    0.2000 



rosette to build in - round - fixed - for pendant with torsionsprings

Dimensions

↔ Ø52xH50 mm  Ø44 mm

⊥ L 69 mm

Materials

Aluminium 1M | 2M

Options

S2/.. SET FLAT SPRINGS

Ref

1695.1M 

1695.2M 

*built-in
with strain relief for pendant*

1696/.. - MARIE

S1 IP20    0.1700 



rosette to build in - round - for pendant with torsionsprings

Dimensions

↔ Ø52xH50 mm  Ø44 mm

⊥ L 96 mm

Materials

Aluminium 1M | 2M

Options

S2/.. SET FLAT SPRINGS

Ref

1696.1M 

1696.2M 

*built-in
with strain relief for pendant*



1714/.. - ROSETTE IN

S1 IP20   

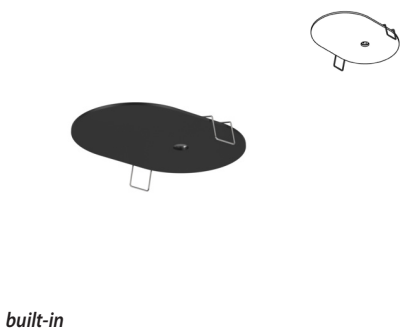

rosette to build in - round

Dimensions

→ L120xB85 mm  Ø35-40 mm
 ↙ L 45 mm

Materials

Aluminium 1M | 2M

Options

P040/.. STRAIN RELIEF - TREKONTLASTING
 P039/.. STRAIN RELIEF - TREKONTLASTING
 P038/.. STRAIN RELIEF - TREKONTLASTING

Ref

1714.1M 
 1714.2M 

built-in

1715/.. - ROSETTE IN

S1 IP20   

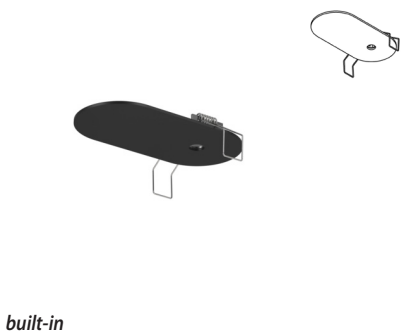

rosette to build in - round

Dimensions

→ L120xB60 mm  Ø35-40 mm
 ↙ L 45 mm

Materials

Aluminium 1M | 2M

Options

P040/.. STRAIN RELIEF - TREKONTLASTING
 P039/.. STRAIN RELIEF - TREKONTLASTING
 P038/.. STRAIN RELIEF - TREKONTLASTING

Ref

1715.1M 
 1715.2M 

built-in

1716/.. - ROSETTE IN

S1 IP20    0.0750 

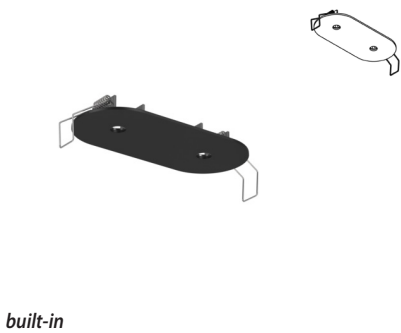

rosette to build in - round

Dimensions

→ L130xB60 mm  100x35 mm
 ↙ L 45 mm

Materials

Aluminium 1M | 2M

Options

P040/.. STRAIN RELIEF - TREKONTLASTING
 P039/.. STRAIN RELIEF - TREKONTLASTING
 P038/.. STRAIN RELIEF - TREKONTLASTING

Ref

1716.1M 
 1716.2M 

built-in

1718/.. - ROSETTE IN

S1 IP20    0.1500 

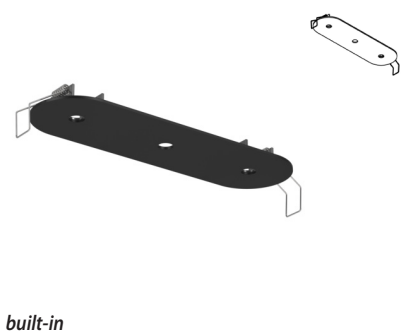

rosette to build in - round

Dimensions

→ L200xB60 mm  170x35 mm
 ↙ L 45 mm

Materials

Aluminium 1M | 2M

Options

P040/.. STRAIN RELIEF - TREKONTLASTING
 P039/.. STRAIN RELIEF - TREKONTLASTING
 P038/.. STRAIN RELIEF - TREKONTLASTING

Ref

1718.1M 
 1718.2M 

built-in



ACCESSORIES



ROSETTE IN



100/... - ROSETTE M6-M8-M10-D8,3

S1 IP20



rosette to build in - round - with swivel B3

Dimensions

Ø100 mm Ø80 mm

L 55 mm

Materials

Aluminium 1 | 1M | 2 | 2M | 14 | 11

Kleur	100.D8,3/..	100.M10/..	100.M6/..	100.M8/..
	H	H	H	H

1
1M
2
2M
14
11

built-in
for pendants only - not for spots

065/... - ROSETTE M6-M8-M10-D8,3

S1 IP20



rosette to build in - round - with swivel B3

Dimensions

Ø65 mm Ø42-45 mm

L 55 mm

Materials

Aluminium 1 | 1M | 2 | 2M | 14 | 11

Messing 7 | 4 | 16 | 13

Kleur	065.D8,3/..	065.M10/..	065.M6/..	065.M8/..
	H	H	H	H

1M
2
2M
14
7
11
4
16
13

built-in
for pendants only - not for spots

080/... - ROSETTE M6-M8-M10-D8,3

S1 IP20



rosette to build in - round - with swivel B3

Dimensions

Ø80 mm Ø42-60 mm

L 55 mm

Materials

Aluminium 1 | 1M | 2 | 2M | 14 | 11





Messing 4 | 16 | 13

Kleur	080.D8,3/..	080.M10/..	080.M6/..	080.M8/..
	H	H	H	H

1
1M
2
2M
14
11
4
16
13

built-in
for pendants only - not for spots

1428/.. - ROSETTE IN WITH SCREWS

IP20    

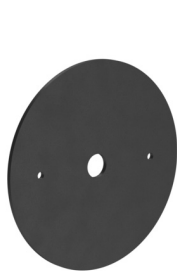

rosette to build in - round

Dimensions

↔ Ø90 mm ↔ 59 mm

Materials





Aluminium 1M | 2M | 14
 Messing 4

Ref

1428.1M 
 1428.2M 
 1428.14 
 1428.4 

built-in
 2 screws included

1429/.. - ROSETTE IN WITH SCREWS

IP20    

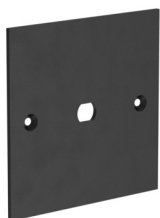

rosette to build in - square

Dimensions

↔ L80xB80 mm ↔ 59 mm

Materials

Aluminium 1M | 2M 1429.23
 Messing 16 | 23





Ref

1429.1M 
 1429.2M 
 1429.16 
 1429.23 

built-in
 2 screws included

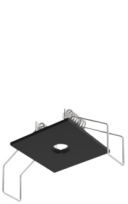



40.10/.. - ROSETTE IN

S1 IP20    0.0385 

		rosette to build in - square	Ref	
<i>built-in</i>		Dimensions		
		 L40xB40 mm	 Ø30 mm	
		 L 55 mm		
		Materials		
		Aluminium	1 1M 2 2M 14 11	40.10.1
		Inox 316	5	40.10.1M
		Messing	4 16 13	40.10.2
		Options		40.10.2M
		P040/..	STRAIN RELIEF - TREKONTLASTING	40.10.14
		P039/..	STRAIN RELIEF - TREKONTLASTING	40.10.11
		P038/..	STRAIN RELIEF - TREKONTLASTING	40.10.5
				40.10.4
				40.10.16
			40.10.13	

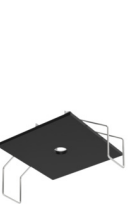



50.10/.. - ROSETTE IN

S1 IP20    0.0383 

		rosette to build in - square	Ref	
<i>built-in</i>		Dimensions		
		 L50xB50 mm	 Ø30 mm	
		 L 55 mm		
		Materials		
		Aluminium	1 1M 2 2M 14 11	50.10.1
		Messing	4 16 13	50.10.1M
		Options		50.10.2
		P040/..	STRAIN RELIEF - TREKONTLASTING	50.10.2M
		P039/..	STRAIN RELIEF - TREKONTLASTING	50.10.4
		P038/..	STRAIN RELIEF - TREKONTLASTING	50.10.11
				50.10.13
				50.10.14
				50.10.16

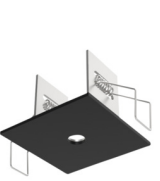
60.10/.. - ROSETTE IN

S1 IP20    0.0500 

		rosette to build in - square	Ref	
<i>built-in</i>		Dimensions		
		 L60xB60 mm	 Ø39-40 mm	
		 L 55 mm		
		Materials		
		Aluminium	1 1M 2 2M 14 11	60.10.1
		Inox 316	5	60.10.1M
		Messing	4 16 13	60.10.2
		Options		60.10.2M
		S2/..	SET FLAT SPRINGS	60.10.14
		P040/..	STRAIN RELIEF - TREKONTLASTING	60.10.11
		P039/..	STRAIN RELIEF - TREKONTLASTING	60.10.5
		P038/..	STRAIN RELIEF - TREKONTLASTING	60.10.4
				60.10.16
			60.10.13	

80.10/.. - ROSETTE IN

S1 IP20    CE

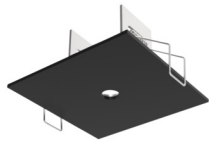

rosette to build in - square

Dimensions

↔ L80xB80 mm

 Ø60 mm

⊥ 55 mm

Materials

Aluminium

1 | 1M | 2 | 2M | 14 | 11

Inox 316

5

Messing

4 | 16 | 13

Options

S2/.. SET FLAT SPRINGS

P040/.. STRAIN RELIEF - TREKONTLASTING

P039/.. STRAIN RELIEF - TREKONTLASTING

P038/.. STRAIN RELIEF - TREKONTLASTING

Ref

80.10.1

80.10.1M

80.10.2

80.10.2M

80.10.4

80.10.5

80.10.11

80.10.13

80.10.14

80.10.16



built-in

100.10/.. - ROSETTE IN

S1 IP20    CE

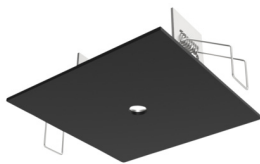

rosette to build in - square

Dimensions

↔ L100xB100 mm

 Ø80 mm

⊥ 55 mm

Materials

Aluminium

1 | 1M | 2 | 2M | 14 | 11

Inox 316

5

Messing

4 | 16 | 13

Options

S2/.. SET FLAT SPRINGS

P040/.. STRAIN RELIEF - TREKONTLASTING

P039/.. STRAIN RELIEF - TREKONTLASTING

P038/.. STRAIN RELIEF - TREKONTLASTING

Ref

100.10.1

100.10.1M

100.10.2

100.10.2M

100.10.14

100.10.11

100.10.5

100.10.4

100.10.16

100.10.13



built-in

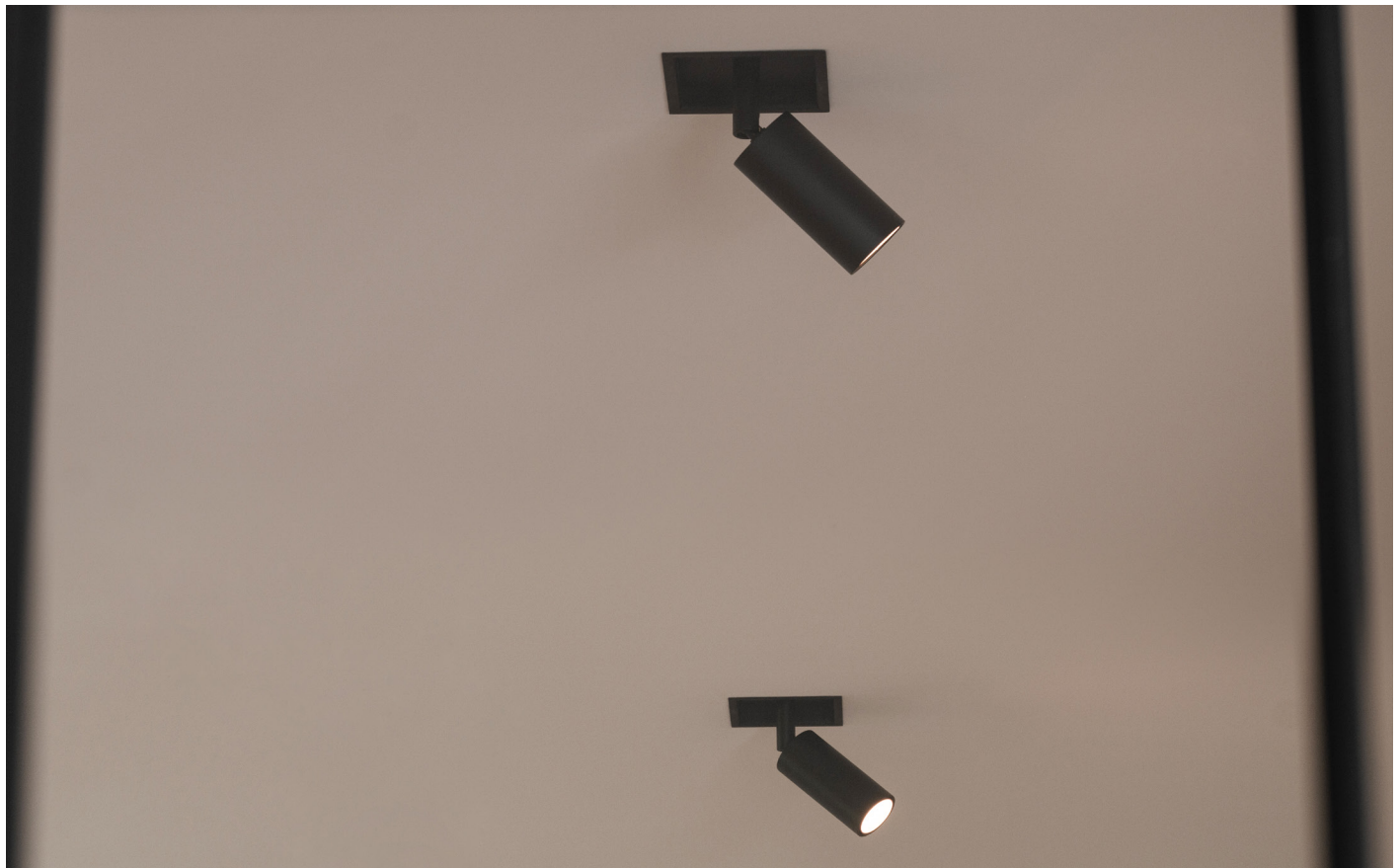

ACCESSORIES

ROSETTE IN

065.65/... - ROSETTE M6-M8-M10-D8,3

S1 IP20   



rosette to build in - square - with swivel B3

Dimensions

↔ L65xB65 mm  Ø42-45 mm

⊥ L 55 mm

Materials



Aluminium 1 | 1M | 2 | 2M | 14 | 11

Messing 4 | 16 | 13

Kleur	065.65.D8,3/..	065.65.M10/..	065.65.M6/..	065.65.M8/..
	H	H	H	H
1				
1M				
2				
2M				
14				
11				
4				
16				
13				

*built-in
for pendants only - not for spots*

080.80/... - ROSETTE M6-M8-M10-D8,3

 S1 IP20   



rosette to build in - square - with swivel B3

Dimensions

↔ L80xB80 mm  Ø42-60 mm

⊥ L 55 mm

Materials

Aluminium 1 | 1M | 2 | 2M | 14 | 11

Messing 4 | 16 | 13

Kleur	080.80.D8,3/..	080.80.M10/..	080.80.M6/..	080.80.M8/..
	H	H	H	H
1				
1M				
2				
2M				
14				
11				
4				
16				
13				

*built-in
for pendants only - not for spots*



100.100/././.. - ROSETTE IN

S1 IP20   CE



rosette to build in - square - with swivel B3

Dimensions

 L100xB100 mm  Ø80 mm

 55 mm

Materials

Aluminium 1 | 1M | 2 | 2M | 14 | 11

Kleur	100.100.D8,3/..	100.100.M10/..	100.100.M6/..	100.100.M8/..
	H	H	H	H
1				
1M				
2				
2M				
14				
11				

built-in
for pendants only - not for spots

ACCESSORIES
ROSETTE IN

1668/.. - ROSETTE WALL IN

IP20    



accessories for built-up spot - with switch - with Helia built-in box 275 or 276 (4 screws)



Dimensions

 B80xH90 mm

Materials

Aluminium 1M | 2M | 14

Ref

1668.1M	
1668.2M	
1668.14	

built-in
Helia box included

1669/.. - ROSETTE WALL IN

IP20    

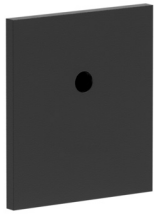

accessories for built-up spot - without switch - with built-in box Helia 275 or 276 (4 screws)



Dimensions

 B80xH90 mm

Materials

Aluminium 1M | 2M | 14

Ref

1669.1M	
1669.2M	
1669.14	

built-in
Helia box included

1677/.. - ROSETTE WALL IN

IP20    

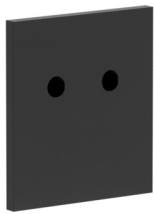

accessories for built-up spot - without switch - with built-in box Helia 275 or 276 (4 screws)



Dimensions

 B80xH90 mm

Materials

Aluminium 1M | 2M | 14

Ref

1677.1M	
1677.2M	
1677.14	

built-in
Helia box included

33../.. - ZIA BASE Ø30

S1 IP20



built-in base with swivel - round - M10-M6-M8-D8,3 - without transformer

Dimensions

Ø33xH55 mm

 Ø30 mm

Materials

Aluminium 1 | 1M | 2 | 2M | 14 | 11
 Messing 4 | 16 | 13

Options

S6.30/.. PLASTERKIT

Kleur	33D8,3/..	33M10/..	33M6/..	33M8/..
	H	H	H	H
1				
1M				
2				
2M				
14				
11				
4				
16				
13				

built-in
 ex. 33M6/16 + jazz 9010/16

50M8../.. - ZIA BASE Ø39-40

S1 IP20



built-in base with swivel - round - directional - without transformer

Dimensions

Ø50xH50 mm

 Ø39-40 mm

60 mm

Materials

Aluminium 1M | 2M | 14
 Messing 4 | 16 | 13

Ref

50M8.1M	
50M8.2M	
50M8.4	
50M8.13	
50M8.14	
50M8.16	

built-in

1433/.. - ROSETTE UP

~230V



built-up base for pendant - round - with recessed cover plate

Dimensions

↔ Ø65xH35 mm

Materials

Aluminium	1M 2M 14 142 214 29
Aluminium / Messing	216
Aluminium / Roodkoper	228

Ref

1433.1M
1433.2M
1433.14
1433.142
1433.214
1433.216
1433.29
1433.228



built-up

1434/.. - ROSETTE UP

~230V



built-up base for pendant - square - with recessed cover plate

Dimensions

↔ L65xB65xH34 mm

Materials

Aluminium	1M 2M 14 142 214 29
Aluminium / Messing	216
Aluminium / Roodkoper	228

Ref

1434.1M
1434.2M
1434.14
1434.29
1434.142
1434.214
1434.216
1434.228



built-up



054B/.. - ROSETTE for textile cable

~230V



built-up base - built-up base with strain relief for 1 textile cable

Dimensions

↔ Ø64xH41 mm

Materials

Aluminium	1M 2M 14
Aluminium / Roodkoper	282
Messing	4 16 13 23
Rood koper	28

Ref

054B.1M	
054B.2M	
054B.14	
054B.4	
054B.16	
054B.13	
054B.23	
054B.28	
054B.282	

built-up

055B/.. - ROSETTE for textile cable

~230V



built-up base - with strain relief for 1 textile cable

Dimensions

↔ Ø62xH30 mm

Materials

Aluminium	1M 2M 14
Aluminium / Roodkoper	282
Messing	4 16 13 23
Rood koper	28

Ref

055B.1M	
055B.2M	
055B.14	
055B.4	
055B.16	
055B.13	
055B.23	
055B.28	
055B.282	

built-up

057/.. - ROSETTE for textile cable

~230V



built-up base - built-up base with strain relief for 1 textile cable + m steel cable

Dimensions

↔ Ø62xH30 mm

Materials

Aluminium	1M 2M 14
Messing	16 13 23
Rood koper	28

Ref

057.1M	
057.2M	
057.14	
057.16	
057.13	
057.23	
057.28	

built-up
the workload is 4 - 15 kg

ACCESSORIES

ROSETTE UP

058/.. - ROSETTE for textile cable

~230V  IP20    0.1825 

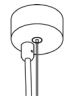

built-up base - built-up base with strain relief for 1 textile cable + m steel cable with height controller

Dimensions

↔ Ø62xH30 mm

Materials

Aluminium 1M | 2M | 14
Messing 16 | 13

Ref

058.1M	
058.2M	
058.14	
058.16	
058.13	

built-up
according to rope diameter, the workload is 4 - 15 kg

058.2/.. - ROSETTE for textile cable

~230V  IP20    0.1360 



built-up base - built-up base with strain reliefs for 2 textile cables + hole for steel cable

Dimensions

↔ Ø62xH30 mm

Materials

Aluminium 1M | 2M | 14
Messing 16 | 13

Options

P041/.. STAALKABEL

Ref

058.2.1M	
058.2.2M	
058.2.13	
058.2.14	
058.2.16	

built-up
steel cable not included

058.3/.. - ROSETTE for textile cable

~230V  IP20    0.1825 



built-up base - built-up base with strain reliefs for 3 textile cables + hole for steel cable

Dimensions

↔ Ø62xH30 mm

Materials

Aluminium 1M | 2M | 14
Messing 16 | 13

Options

P041/.. STAALKABEL

Ref

058.3.1M	
058.3.2M	
058.3.14	
058.3.16	
058.3.13	

built-up
steel cable not included



059.1/.. - ROSETTE for textile cable

~230V



IP20



built-up base - built-up base with strain relief for 1 textile cable

Dimensions

↔ Ø104xH34 mm

Materials

Aluminium 1M | 2M | 14
Messing 16 | 13

Ref

059.1.1M



059.1.2M



059.1.14



059.1.16



059.1.13



built-up

059.4/.. - ROSETTE for textile cable

~230V



IP20



built-up base - built-up base with strain reliefs for 4 textile cables

Dimensions

↔ Ø104xH34 mm

Materials

Aluminium 1M | 2M | 14
Messing 16 | 13

Ref

059.4.1M



059.4.2M



059.4.13



059.4.14



059.4.16



built-up

059.5/.. - ROSETTE for textile cable

~230V



IP20

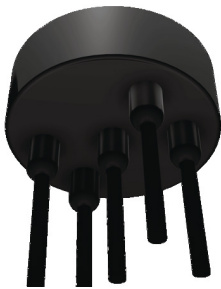

built-up base - built-up base with strain reliefs for 5 textile cables

Dimensions

↔ Ø104xH34 mm

Materials

Aluminium 1M | 2M | 14
Messing 16 | 13

Ref

059.5.1M



059.5.2M



059.5.14



059.5.16



059.5.13



built-up

059.6/.. - ROSETTE for textile cable

~230V



IP20

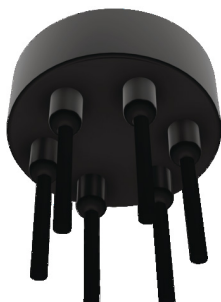

built-up base - built-up base with strain reliefs for 6 textile cables

Dimensions

↔ Ø104xH34 mm

Materials

Aluminium 1M | 2M | 14
Messing 16 | 13

Ref

059.6.1M



059.6.2M



059.6.14



059.6.16



059.6.13



built-up

059.7/.. - ROSETTE for textile cable

~230V

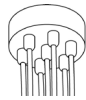
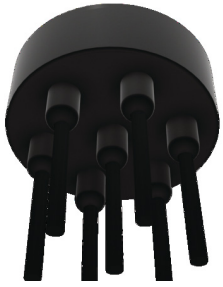

built-up base - built-up base with strain reliefs for 7 textile cables

Dimensions

↔ Ø104xH34 mm

Materials

Aluminium 1M | 2M | 14
 Messing 16 | 13

Ref

- 059.7.1M
- 059.7.2M
- 059.7.13
- 059.7.14
- 059.7.16

built-up



071/.. - ROSETTE for textile cable

~230V



IP20



built-up base - with strain relief for 1 textile cable

Dimensions

↔ Ø82xH32 mm

Materials

Aluminium

1M | 2M | 14

Messing

16 | 13

Ref

071.1M

071.2M

071.14

071.16

071.13



built-up

072/.. - ROSETTE for textile cable

IP20



built-up base - built-up base with strain relief for 1 textile cable + m steel cable

Dimensions

↔ Ø82xH32 mm

Materials

Aluminium

1M | 2M | 14

Messing

16 | 13

Ref

072.1M

072.2M

072.13

072.14

072.16



built-up

according to rope diameter, the workload is 4 - 15 kg

073/.. - ROSETTE for textile cable

~230V



IP20



built-up base - built-up base with strain relief for 1 textile cable + m steel cable with height controller

Dimensions

↔ Ø82xH32 mm

Materials

Aluminium

1M | 2M | 14

Messing

16 | 13

Ref

073.1M

073.2M

073.14

073.16

073.13



built-up

According to rope diameter, the workload is 4 - 15 kg.

073.2/.. - ROSETTE for textile cable

~230V



IP20



built-up base - built-up base with strain reliefs for 2 textile cables

Dimensions

↔ Ø82xH32 mm

Materials

Aluminium

1M | 2M | 14

Messing

16 | 13

Ref

073.2.1M

073.2.2M

073.2.14

073.2.16

073.2.13



built-up

073.3/.. - ROSETTE for textile cable

~230V



IP20



0.2517



built-up base - built-up base with strain reliefs for 3 textile cables

Dimensions

↔ Ø82xH32 mm

Materials

Aluminium 1M | 2M | 14
Messing 16 | 13

Ref

073.3.1M	●
073.3.2M	●
073.3.14	●
073.3.16	●
073.3.13	●

built-up

073B.3/.. - ROSETTE for textile cable

~230V



IP20



0.1950



built-up base - built-up base with strain reliefs for 3 textile cables

Dimensions

↔ Ø82xH32 mm

Materials

Aluminium 1M | 2M | 14
Messing 16 | 13

Ref

073B.3.1M	●
073B.3.2M	●
073B.3.14	●
073B.3.16	●
073B.3.13	●

built-up
steel cable not included

073.4/.. - ROSETTE for textile cable

~230V



IP20



0.2233



built-up base - built-up base with strain reliefs for 4 textile cables

Dimensions

↔ Ø82xH32 mm

Materials

Aluminium 1M | 2M | 14
Messing 16
Rood koper 28

Ref

073.4.1M	●
073.4.2M	●
073.4.14	●
073.4.16	●
073.4.28	●

built-up

073.5/.. - ROSETTE for textile cable

~230V



IP20



0.3300



built-up base - built-up base with strain reliefs for 5 textile cables

Dimensions

↔ Ø82xH32 mm

Materials

Aluminium 1M | 2M | 14
Messing 16 | 13

Ref

073.5.1M	●
073.5.2M	●
073.5.14	●
073.5.16	●
073.5.13	●

built-up

001/.. - ROSETTE UP

IP20 0.0613

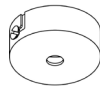

built-up base - round

Dimensions

↔ Ø55xH22 mm

Materials

Aluminium 1 | 1M | 2 | 2M | 11
Messing 4 | 16 | 13 | 23

Options

P040/.. STRAIN RELIEF - TREKONTLASTING
P039/.. STRAIN RELIEF - TREKONTLASTING
P038/.. STRAIN RELIEF - TREKONTLASTING

Ref

- 001.1
- 001.1M
- 001.2
- 001.2M
- 001.11
- 001.4
- 001.16
- 001.13
- 001.23

built-up

003/.. - ROSETTE UP

IP20 0.0979



built-up base - round

Dimensions

↔ Ø55xH22 mm

Materials

Aluminium 1 | 1M | 2 | 2M | 14 | 11
Messing 4 | 16 | 13 | 23

Options

P040/.. STRAIN RELIEF - TREKONTLASTING
P039/.. STRAIN RELIEF - TREKONTLASTING
P038/.. STRAIN RELIEF - TREKONTLASTING

Ref

- 003.1
- 003.1M
- 003.2
- 003.2M
- 003.14
- 003.11
- 003.4
- 003.16
- 003.13
- 003.23

built-up

004/.. - ROSETTE UP

IP20 0.0946



built-up base - round

Dimensions

↔ Ø60xH24 mm

Materials

Aluminium 1 | 1M | 2 | 2M | 14 | 11
Messing 4 | 16 | 13 | 23

Options

P040/.. STRAIN RELIEF - TREKONTLASTING
P039/.. STRAIN RELIEF - TREKONTLASTING
P038/.. STRAIN RELIEF - TREKONTLASTING

Ref

- 004.1
- 004.1M
- 004.2
- 004.2M
- 004.14
- 004.11
- 004.4
- 004.16
- 004.13
- 004.23

built-up

009/.. - ROSETTE UP



built-up base - round

Dimensions

↔ Ø40xH30 mm

Materials

Aluminium 1M | 2M | 14 | 11 | 95 | 230 | 119 | 53 | 46 | 21
 Messing 4 | 16 | 13 | 13M | 23

Options

P040/.. STRAIN RELIEF - TREKONTLASTING
 P039/.. STRAIN RELIEF - TREKONTLASTING
 P038/.. STRAIN RELIEF - TREKONTLASTING

Ref

009.1M
 009.2M
 009.14
 009.11
 009.4
 009.16
 009.95
 009.13
 009.13M
 009.23
 009.230
 009.119
 009.53
 009.46
 009.21



built-up

005/.. - ROSETTE UP



built-up base - round

Dimensions

↔ Ø60xH25 mm

Materials

Aluminium 1 | 1M | 2 | 2M | 14 | 11 | 119 | 53 | 46 | 21
 Messing 4 | 16 | 13 | 13M | 23

Options

P040/.. STRAIN RELIEF - TREKONTLASTING
 P039/.. STRAIN RELIEF - TREKONTLASTING
 P038/.. STRAIN RELIEF - TREKONTLASTING

Ref

005.1
 005.1M
 005.2
 005.2M
 005.14
 005.11
 005.4
 005.16
 005.13
 005.13M
 005.23
 005.119
 005.53
 005.46
 005.21



built-up



2025/.. - ROSETTE UP



built-up



built-up base - round

Dimensions

↔ Ø60xH40 mm

Materials

Aluminium 1 | 1M | 2 | 2M | 14 | 11 | 10

Messing 4 | 16 | 13 | 23

Options

P040/.. STRAIN RELIEF - TREKONTLASTING

P039/.. STRAIN RELIEF - TREKONTLASTING

P038/.. STRAIN RELIEF - TREKONTLASTING

Ref

2025.1

2025.1M

2025.2

2025.2M

2025.4

2025.10

2025.11

2025.13

2025.14

2025.16

2025.23



020/.. - ROSETTE UP



built-up



built-up base - round

Dimensions

↔ Ø60xH40 mm

Materials

Aluminium 1 | 1M | 2 | 2M | 14 | 11

Messing 4 | 16 | 13

Options

P040/.. STRAIN RELIEF - TREKONTLASTING

P039/.. STRAIN RELIEF - TREKONTLASTING

P038/.. STRAIN RELIEF - TREKONTLASTING

Ref

020.1

020.1M

020.2

020.2M

020.14

020.11

020.4

020.16

020.13



021.ZT/.. - ROSETTE UP



built-up



built-up base - round - without transformer

Dimensions

↔ Ø60xH65 mm

Materials

Aluminium 1 | 1M | 2 | 2M | 14 | 11

Messing 4 | 16 | 13

Options

P040/.. STRAIN RELIEF - TREKONTLASTING

P039/.. STRAIN RELIEF - TREKONTLASTING

RSD35005E/.. DRIVER 350mA

RSD50007E/.. DRIVER 500mA

P038/.. STRAIN RELIEF - TREKONTLASTING

Ref

021.ZT.1

021.ZT.1M

021.ZT.2

021.ZT.2M

021.ZT.14

021.ZT.11

021.ZT.4

021.ZT.16

021.ZT.13



2024/.. - ROSETTE UP



built-up
only for profiles



built-up base - round

Dimensions

↔ Ø60xH68 mm

Materials

Aluminium 1 | 1M | 2 | 2M | 11 | 10

Ref

2024.1

2024.1M

2024.2

2024.2M

2024.10

2024.11



061/.. - ROSETTE UP

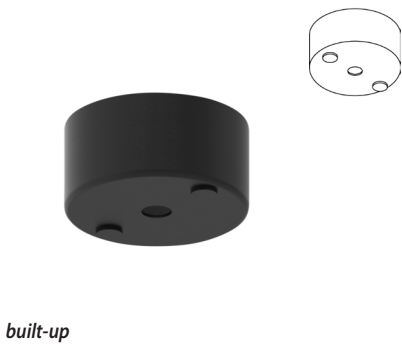

built-up base - base for built-up spotlight

Dimensions

↔ Ø62xH30 mm

Materials

Aluminium 1M | 2M | 14
 Messing 4 | 16 | 13 | 23

Options

P040/.. STRAIN RELIEF - TREKONTLASTING
 P039/.. STRAIN RELIEF - TREKONTLASTING
 P038/.. STRAIN RELIEF - TREKONTLASTING

Ref

- 061.1M
- 061.2M
- 061.14
- 061.4
- 061.16
- 061.13
- 061.23

053/.. - OPHANGING VOOR PENDEL

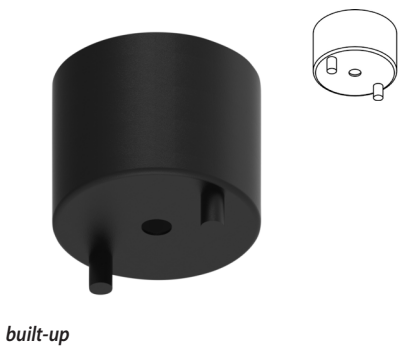

built-up base for pendant - round

Dimensions

↔ Ø70xH40 mm

Materials

Aluminium 1M | 2M | 14 | 46
 Messing 4 | 16 | 13 | 23
 Rood koper 28

Options

P040/.. STRAIN RELIEF - TREKONTLASTING
 P039/.. STRAIN RELIEF - TREKONTLASTING
 P038/.. STRAIN RELIEF - TREKONTLASTING

Ref

- 053.1M
- 053.2M
- 053.14
- 053.4
- 053.16
- 053.13
- 053.23
- 053.46
- 053.28

049/.. - ROZET VOOR OPBOUWSPOT

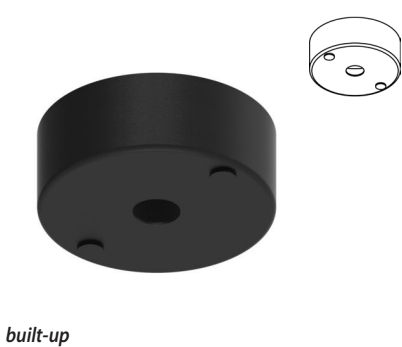

built-up base for spot - round

Dimensions

↔ Ø80xH30 mm

Materials

Aluminium 1M | 2M | 14

Options

P040/.. STRAIN RELIEF - TREKONTLASTING
 P039/.. STRAIN RELIEF - TREKONTLASTING
 P038/.. STRAIN RELIEF - TREKONTLASTING

Ref

- 049.1M
- 049.2M
- 049.14

042/.. - ROZET VOOR OPBOUWSPOT

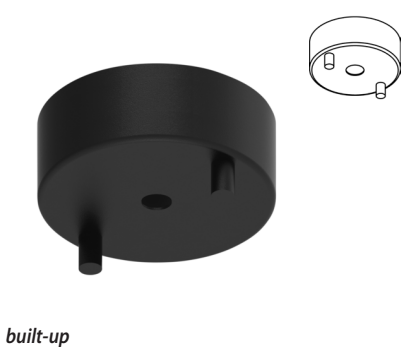

built-up base - round

Dimensions

↔ Ø80xH30 mm

Materials

Aluminium 1M | 2M | 14

Options

P040/.. STRAIN RELIEF - TREKONTLASTING
 P039/.. STRAIN RELIEF - TREKONTLASTING
 P038/.. STRAIN RELIEF - TREKONTLASTING

Ref

- 042.1M
- 042.2M
- 042.14

1559/.. - ROSETTE UP

IP20    0.1217 



built-up base - round

Dimensions

←→ Ø80xH40 mm

Materials

Aluminium 1M | 2M | 14
Messing 4 | 16 | 13 | 23

Options

P040/.. STRAIN RELIEF - TREKONTLASTING
P039/.. STRAIN RELIEF - TREKONTLASTING
TRMINI500MA/.. DRIVER 500mA
P038/.. STRAIN RELIEF - TREKONTLASTING
TRRC7W500/.. DRIVER 500mA
TRMINI6350T/.. DRIVER 350MA
TRRC3W350/.. DRIVER 350MA

Ref

1559.1M
1559.2M
1559.14
1559.4
1559.16
1559.13
1559.23



built-up

1559.SW/.. - ROSETTE UP

IP20    0.4000 



built-up base - round

Dimensions

←→ Ø80xH40 mm

Materials

Aluminium 1M | 2M | 14
Messing 4 | 13 | 23

Options

TRMINI500MA/.. DRIVER 500mA
TRRC7W500/.. DRIVER 500mA
TRMINI6350T/.. DRIVER 350MA
TRRC3W350/.. DRIVER 350MA

Ref

1559.SW.1M
1559.SW.2M
1559.SW.14
1559.SW.4
1559.SW.13
1559.SW.23



built-up

050/.. - ROZET VOOR OPBOUWSPOT

~230V

   IP20    0.2383 



built-up base for spot - round - with LED driver

Dimensions

←→ Ø80xH55 mm

Materials

Aluminium 1M | 2M | 14

Options

P040/.. STRAIN RELIEF - TREKONTLASTING
P039/.. STRAIN RELIEF - TREKONTLASTING
P038/.. STRAIN RELIEF - TREKONTLASTING

Ref

050.1M
050.2M
050.14



built-up
12W 700mA - not dimmable

ACCESSORIES

ROSETTE UP

043/.. - ROZET VOOR OPBOUWSPOT

~230V



IP20



built-up base - round - with LED driver

Dimensions

↔ Ø80xH55 mm

Materials

Aluminium 1M | 2M | 14

Options

- P040/.. STRAIN RELIEF - TREKONTLASTING
- P039/.. STRAIN RELIEF - TREKONTLASTING
- P038/.. STRAIN RELIEF - TREKONTLASTING

Ref

043.1M

043.2M

043.14



built-up
12W 700mA - not dimmable



1647/.. - ROSETTE UP + DRIVER



built-up base - round - with 1x TR89800255 | 15W - 350mA - with LED driver

Dimensions

↔ Ø70xH170 mm

Materials

Aluminium 1M | 2M

Ref

1647.1M

1647.2M



built-up

1649/.. - ROSETTE UP + DRIVER

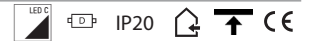

built-up base - round - with 2x TR89800255 | 30W - 350mA - with LED driver

Dimensions

↔ Ø70xH170 mm

Materials

Aluminium 1M | 2M

Ref

1649.1M

1649.2M



built-up

1653/.. - ROSETTE UP + DRIVER

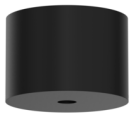

built-up base - round - with driver 350mA 4,5W - dimmable phase cut - with LED driver

Dimensions

↔ Ø65xH45 mm

Materials

Aluminium 1M | 2M

Options

- P040/.. STRAIN RELIEF - TREKONTLASTING
- P039/.. STRAIN RELIEF - TREKONTLASTING
- P038/.. STRAIN RELIEF - TREKONTLASTING

Ref

1653.1M

1653.2M



built-up

032/.. - ROSETTE UP



built-up base - for suspension light with 3 steel cables

Dimensions

↔ Ø100xH32 mm 🔧 Ø80 mm

Materials

Aluminium 1 | 1M | 2M | 14 | 11
Messing 4 | 16 | 13

Options

- P040/.. STRAIN RELIEF - TREKONTLASTING
- P039/.. STRAIN RELIEF - TREKONTLASTING
- P038/.. STRAIN RELIEF - TREKONTLASTING

Ref

032.1

032.1M

032.2M

032.14

032.11

032.4

032.16

032.13



built-up

1719/.. - ROSETTE UP

III S1 IP20   CE



rosette to build in - round

Dimensions

↔ L120xB85 mm

Materials

Aluminium 1M | 2M

Options

- P040/.. STRAIN RELIEF - TREKONTLASTING
- P039/.. STRAIN RELIEF - TREKONTLASTING
- P038/.. STRAIN RELIEF - TREKONTLASTING

Ref

1719.1M



1719.2M



built-up

059/.. - ROSETTE M10

IP20    0.1250 CE



built-up base

Dimensions

↔ Ø104xH34 mm

Materials

Aluminium 1M | 2M | 14
 Messing 16 | 13

Options

- P040/.. STRAIN RELIEF - TREKONTLASTING
- P039/.. STRAIN RELIEF - TREKONTLASTING
- P038/.. STRAIN RELIEF - TREKONTLASTING

Ref

059.1M



059.2M



059.14



059.16



059.13



built-up

1604/.. - ROSETTE UP

III IP20 0.0650 CE

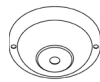

built-up base

Dimensions

↔ Ø90xH30 mm 81 mm

Materials

Aluminium 1 | 1M | 2 | 2M | 11
Messing 4 | 16 | 13 | 23 | 97

Options

P040/.. STRAIN RELIEF - TREKONTLASTING
P039/.. STRAIN RELIEF - TREKONTLASTING
P038/.. STRAIN RELIEF - TREKONTLASTING

Ref

1604.1
1604.1M
1604.2
1604.2M
1604.4
1604.11
1604.13
1604.16
1604.23
1604.97

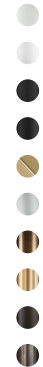

1608/.. - ROSETTE UP

III IP20 0.1400 CE

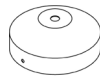
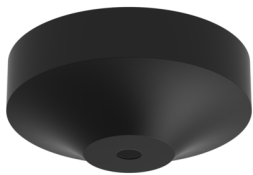

built-up base

Dimensions

↔ Ø100xH40 mm

Materials

Aluminium 1 | 1M | 2 | 2M | 11
Messing 4 | 16 | 13 | 23 | 97

Options

P040/.. STRAIN RELIEF - TREKONTLASTING
P039/.. STRAIN RELIEF - TREKONTLASTING
P038/.. STRAIN RELIEF - TREKONTLASTING
TRRC7W500/.. DRIVER 500mA
TRMINI6350T/.. DRIVER 350MA

Ref

1608.1
1608.1M
1608.2
1608.2M
1608.4
1608.11
1608.13
1608.16
1608.23
1608.97

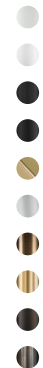

1609/.. - ROSETTE UP

III IP20 CE

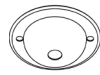

built-up base

Dimensions

↔ Ø65xH20 mm 52 mm

Materials

Aluminium 1 | 1M | 2 | 2M | 11
Messing 4 | 16 | 13 | 23 | 97

Options

P040/.. STRAIN RELIEF - TREKONTLASTING
P039/.. STRAIN RELIEF - TREKONTLASTING
P038/.. STRAIN RELIEF - TREKONTLASTING

Ref

1609.1
1609.1M
1609.2
1609.2M
1609.4
1609.11
1609.13
1609.16
1609.23
1609.97

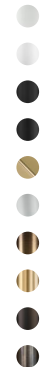

030/.. - ROSETTE UP

III IP20 0.0650 CE

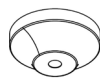

built-up base - built-up base

Dimensions

↔ Ø70xH30 mm

Materials

Aluminium 1 | 1M | 2 | 2M | 11
Messing 4 | 16 | 13 | 23

Options

P040/.. STRAIN RELIEF - TREKONTLASTING
P039/.. STRAIN RELIEF - TREKONTLASTING
P038/.. STRAIN RELIEF - TREKONTLASTING

Ref

030.1
030.1M
030.2
030.2M
030.11
030.4
030.16
030.13
030.23



033.B3.D8,3/.. - ROZET VOOR PENDEL

IP20    0.1733 



built-up base for pendant - round - with swivel B3







Dimensions

↔ Ø60xH40 mm

Materials

Aluminium 1M | 2M | 14
Messing 4 | 13 | 23

Ref

033.B3.D8.3.1M 
033.B3.D8.3.2M 
033.B3.D8.3.4 
033.B3.D8.3.13 
033.B3.D8.3.14 
033.B3.D8.3.23 

built-up

033.B3.D12/.. - ROZET VOOR PENDEL

IP20    0.1300 



built-up base for pendant - round - with swivel B3 - rod Ø12mm







Dimensions

↔ Ø60xH40 mm

Materials

Aluminium 1M | 2M | 14
Messing 4 | 13 | 23

Ref

033.B3.D12.1M 
033.B3.D12.2M 
033.B3.D12.14 
033.B3.D12.4 
033.B3.D12.13 
033.B3.D12.23 

built-up

060.B3.D8,3/.. - ROSETTE for pendant

IP20    0.4550 



built-up base - built-up base for bar Ø8mm B3









Dimensions

↔ Ø70xH40 mm

Materials

Aluminium 1M | 2M | 14
Messing 4 | 16 | 13 | 23
Rood koper 28

Ref

060.B3.D8.3.1M 
060.B3.D8.3.2M 
060.B3.D8.3.4 
060.B3.D8.3.13 
060.B3.D8.3.14 
060.B3.D8.3.16 
060.B3.D8.3.23 
060.B3.D8.3.28 

built-up

060.B3.D12/.. - ROSETTE for pendant

IP20   



built-up base - built-up rosette for bar Ø12 mm B3









Dimensions

↔ Ø70xH40 mm

Materials

Aluminium 1M | 2M | 14
Messing 4 | 16 | 13 | 23
Rood koper 28

Ref

060.B3.D12.1M 
060.B3.D12.2M 
060.B3.D12.14 
060.B3.D12.4 
060.B3.D12.16 
060.B3.D12.13 
060.B3.D12.23 
060.B3.D12.28 

built-up

020.B3/./.. - ROSETTE -M10-M8-M6-D8,3

IP20   



built-up base - round - with swivel B3

Dimensions

↔ Ø54xH60 mm

Materials

Aluminium 1 | 1M | 2 | 2M | 14 | 11
 Messing 4 | 16 | 13

Kleur	020.B3.D8,3/..	020.B3.M10/..	020.B3.M6/..	020.B3.M8/..
	H	H	H	H

1
1M
2
2M
14
11
4
16
13

built-up
for pendants only - not for spots

021.B3.ZT.D8,3/.. - ROSETTE UP

IP20    



built-up base - round - with swivel B3

Dimensions









↔ Ø60xH90 mm

Materials

Aluminium 1 | 1M | 2 | 2M | 14 | 11
 Messing 4 | 16 | 13

Options

TRRC7W500/.. DRIVER 500mA
 TRMINI6350T/.. DRIVER 350MA
 TRRC3W350/.. DRIVER 350MA

Ref	
021.B3.ZT.D8.3.1	
021.B3.ZT.D8.3.1M	
021.B3.ZT.D8.3.2	
021.B3.ZT.D8.3.2M	
021.B3.ZT.D8.3.14	
021.B3.ZT.D8.3.11	
021.B3.ZT.D8.3.4	
021.B3.ZT.D8.3.16	
021.B3.ZT.D8.3.13	

built-up
for pendants only - not for spots

034.B3/.. - ROZET VOOR PENDEL

IP20    

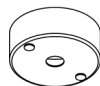







built-up base for pendant - round - with swivel B3

Dimensions

↔ Ø80xH25 mm

Materials

Aluminium 1M | 2M | 14
 Messing 4 | 13 | 23

Ref	
034.B3.1M	
034.B3.2M	
034.B3.14	
034.B3.4	
034.B3.13	
034.B3.23	

built-up

035/.. - ROZET VOOR PENDEL

~230V



built-up base for pendant - round - with swivel B3 - with LED driver

Dimensions

↔ Ø80xH55 mm

Materials

Aluminium 1M | 2M | 14
Messing 4 | 13 | 23

Options

RSD35005E/.. DRIVER 350mA
RSD50007E/.. DRIVER 500mA
TRMINI500MA/.. DRIVER 500mA
TRRC7W500/.. DRIVER 500mA
TRRC3W350/.. DRIVER 350MA

Ref

035.1M ●
035.2M ●
035.4 ●
035.13 ●
035.14 ●
035.23 ●

built-up
12W 700mA - not dimmable

037.B3.D8,3/.. - ROSETTE UP



built-up base - for pendant with swivel B3 - for rod Ø8mm

Dimensions

↔ Ø100xH32 mm ↗ Ø75 mm

Materials

Aluminium 1 | 1M | 2M | 14 | 11
Messing 7 | 4 | 16 | 13 | 23

Ref

037.B3.D8.3.1 ●
037.B3.D8.3.1M ●
037.B3.D8.3.2M ●
037.B3.D8.3.4 ●
037.B3.D8.3.7 ●
037.B3.D8.3.11 ●
037.B3.D8.3.13 ●
037.B3.D8.3.14 ●
037.B3.D8.3.16 ●
037.B3.D8.3.23 ●

built-up

037.B3.D12/.. - ROSETTE UP

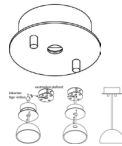

built-up base - for pendant with swivel B3 - for rod Ø12mm

Dimensions

↔ Ø100xH32 mm ↗ Ø75 mm

Materials

Aluminium 1 | 1M | 2M | 14 | 11
Messing 7 | 4 | 16 | 13 | 23

Options

4054/.. MONA LISA Ø550

Ref

037.B3.D12.1 ●
037.B3.D12.1M ●
037.B3.D12.2M ●
037.B3.D12.4 ●
037.B3.D12.7 ●
037.B3.D12.11 ●
037.B3.D12.4 ●
037.B3.D12.16 ●
037.B3.D12.13 ●
037.B3.D12.23 ●

built-up

006/.. - TRANSFORMER BOX



transformer box - empty - without transformer

Dimensions

↔ L90xB39xH90 mm

Materials

Aluminium 1 | 1M | 2 | 2M | 14 | 11
 Messing 4 | 16 | 13

Ref

- 006.1
- 006.1M
- 006.2
- 006.2M
- 006.4
- 006.11
- 006.13
- 006.14
- 006.16

built-up

028/.. - ROSETTE UP

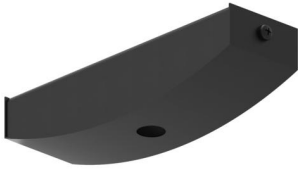

built-up base

Dimensions

↔ L115xB32xH27 mm

Materials

Aluminium 1 | 1M | 2 | 2M | 14 | 11
 Messing 4 | 16 | 13

Ref

- 028.1
- 028.1M
- 028.2
- 028.2M
- 028.14
- 028.11
- 028.4
- 028.16
- 028.13

built-up

1686/.. - ROSETTE UP

IP20   

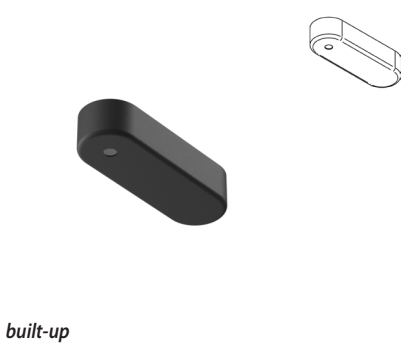

built-up base - round - with rounded corners

Dimensions

↔ L120xB40xH25 mm



Materials

Aluminium 1M | 2M
Messing 16

Options

P040/.. STRAIN RELIEF - TREKONTLASTING
P039/.. STRAIN RELIEF - TREKONTLASTING
P038/.. STRAIN RELIEF - TREKONTLASTING

Ref

1686.1M 
1686.2M 
1686.16 

1687/.. - ROSETTE UP

IP20   

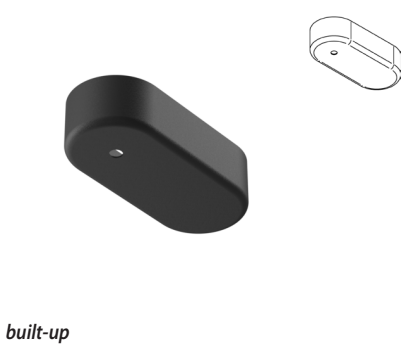

built-up base - round - with rounded corners

Dimensions

↔ L140xB60xH35 mm



Materials

Aluminium 1M | 2M
Messing 16

Options

P040/.. STRAIN RELIEF - TREKONTLASTING
P039/.. STRAIN RELIEF - TREKONTLASTING
P038/.. STRAIN RELIEF - TREKONTLASTING

Ref

1687.1M 
1687.2M 
1687.16 

1688/.. - ROSETTE UP

IP20   

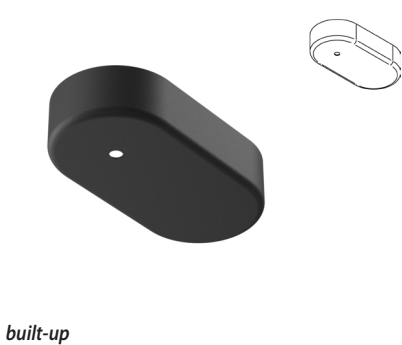

built-up base - round - with rounded corners

Dimensions

↔ L160xB80xH35 mm



Materials

Aluminium 1M | 2M
Messing 16

Options



P040/.. STRAIN RELIEF - TREKONTLASTING
P039/.. STRAIN RELIEF - TREKONTLASTING
P038/.. STRAIN RELIEF - TREKONTLASTING

Ref

1688.1M 
1688.2M 
1688.16 

1654/.. - ROSETTE UP + DRIVER

~230V

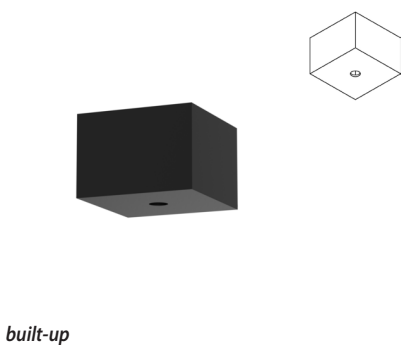

built-up base - square - with driver 350mA 4,5W - dimmable
phase cut - with LED driver

Dimensions

↔ L65xB65xH40 mm

Materials

Aluminium 1M | 2M

Options

P040/.. STRAIN RELIEF - TREKONTLASTING
P039/.. STRAIN RELIEF - TREKONTLASTING
P038/.. STRAIN RELIEF - TREKONTLASTING

Ref

1654.1M 
1654.2M 

017/.. - ROSETTE UP

III IP20    0.0460 

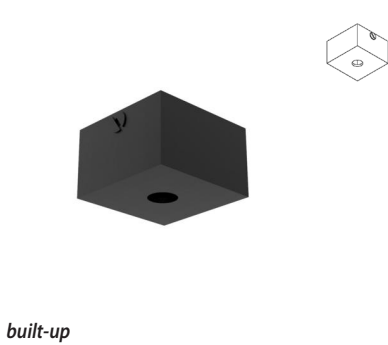

built-up base - square

Dimensions

↔ L40xB40xH25 mm

Materials

Aluminium 1 | 1M | 2 | 2M | 14 | 11
 Messing 4 | 16 | 13 | 23

Options

P040/.. STRAIN RELIEF - TREKONTLASTING
 P039/.. STRAIN RELIEF - TREKONTLASTING
 P038/.. STRAIN RELIEF - TREKONTLASTING

Ref

017.1
 017.1M
 017.2
 017.2M
 017.14
 017.11
 017.4
 017.16
 017.13
 017.23



built-up

025/.. - ROSETTE UP

III IP20    0.1680 

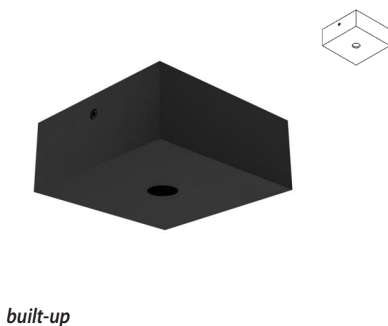

built-up base - square

Dimensions

↔ L60xB60xH25 mm

Materials

Aluminium 1 | 1M | 2 | 2M | 14 | 11
 Messing 4 | 16 | 13

Options

P040/.. STRAIN RELIEF - TREKONTLASTING
 P039/.. STRAIN RELIEF - TREKONTLASTING
 P038/.. STRAIN RELIEF - TREKONTLASTING

Ref

025.1
 025.1M
 025.2
 025.2M
 025.14
 025.11
 025.4
 025.16
 025.13



built-up

027/.. - ROSETTE UP

III IP20    0.2226 

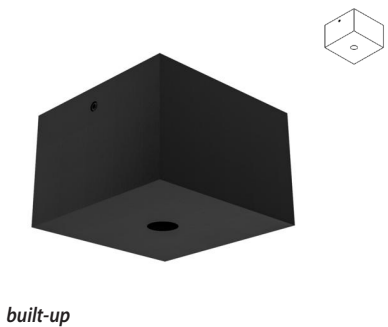

built-up base - square

Dimensions

↔ L60xB60xH40 mm

Materials

Aluminium 1 | 1M | 2 | 2M | 14 | 11
 Messing 4 | 16 | 13

Options

P040/.. STRAIN RELIEF - TREKONTLASTING
 P039/.. STRAIN RELIEF - TREKONTLASTING
 P038/.. STRAIN RELIEF - TREKONTLASTING
 TRRC7W500/.. DRIVER 500mA
 TRRC3W350/.. DRIVER 350MA

Ref

027.1
 027.1M
 027.2
 027.2M
 027.14
 027.11
 027.4
 027.16
 027.13



built-up

026.ZT/.. - ROSETTE UP

III  IP20    0.1300 

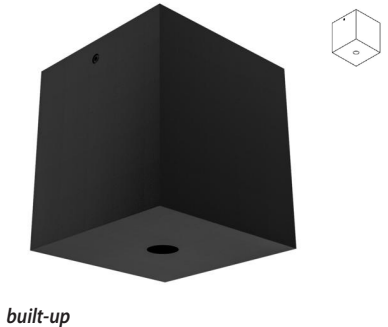

built-up base - square - without transformer

Dimensions

↔ L60xB60xH65 mm

Materials

Aluminium 1 | 1M | 2 | 2M | 14 | 11
 Messing 4 | 16 | 13 | 23

Options

P040/.. STRAIN RELIEF - TREKONTLASTING
 P039/.. STRAIN RELIEF - TREKONTLASTING
 P038/.. STRAIN RELIEF - TREKONTLASTING
 TRRC7W500/.. DRIVER 500mA
 TRMINI6350T/.. DRIVER 350MA
 TRRC3W350/.. DRIVER 350MA

Ref

026.ZT.1
 026.ZT.1M
 026.ZT.2
 026.ZT.2M
 026.ZT.14
 026.ZT.11
 026.ZT.4
 026.ZT.16
 026.ZT.13
 026.ZT.23



built-up

025.B3/./.. - ROSETTE-M10-M8-M6-D8,3

IP20   CE

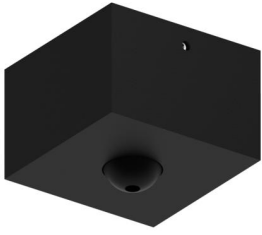

built-up base - square - with swivel B3

Dimensions

←→ L60xB60xH40 mm

Materials

Aluminium 1 | 1M | 2 | 2M | 14 | 11

Messing 4 | 16 | 13

Kleur	025.B3.D8,3/..	025.B3.M10/..	025.B3.M6/..	025.B3.M8/..
	H	H	H	H
1				
1M				
2				
2M				
14				
11				
4				
16				
13				

*built-up
for pendants only - not for spots*



1144/.. - ROSETTE UP

IP20   CE



built-up base - square

Dimensions

↔ L60xB40xH30 mm

Materials

Aluminium

1M | 2M | 14

Ref

1144.1M

1144.2M

1144.14



built-up

1666/.. - ROSETTE WALL

IP20   CE



accessories for built-up spot - without switch

Dimensions

↔ B80xH110xD42 mm 🔧 L90xB65 mm

Materials

Aluminium

1M | 2M | 14

Messing

16 | 13 | 23

Ref

1666.1M

1666.2M

1666.13

1666.14

1666.16

1666.23



built-up

1144.SW/.. - ROSETTE UP

IP20  CE



built-up base - square

Dimensions

↔ L60xB40xH30 mm

Materials

Aluminium

1M | 2M | 14

Ref

1144.SW.1M

1144.SW.2M

1144.SW.14



built-up

1667/.. - ROSETTE WALL

IP20    CE



accessories for built-up spot - with switch

Dimensions

↔ B80xH110xD42 mm 🔧 L90xB65 mm

Materials

Aluminium

1M | 2M | 14

Messing

16 | 13 | 23

Ref

1667.1M

1667.2M

1667.13

1667.14

1667.16

1667.23



built-up

064/.. - ROSETTE HOOK

~230V

⊕ IP20 ⏏ ⚡ 0.2367 CE



Accessories for pendant lamps - round - built-up rosette with open hook for suspension

Dimensions

↔ Ø70xH40 mm

Materials

Inox 31MX | 32X | 37X | 46X
Inox 316 5 | 5BB

Ref

- 064.31MX ●
- 064.32X ●
- 064.37X ●
- 064.5 ●
- 064.5BB ●
- 064.46X ●

built-up



066/.. - ROSETTE HOOK

~230V  IP20    0.1700 



Accessories for pendant lamps - round - built-up rosette with closed hook for suspension

Dimensions

↔ Ø70xH40 mm

Materials

Aluminium 1M | 2M | 14
Messing 4 | 16 | 13 | 23

Ref

066.1M
066.2M
066.4
066.13
066.14
066.16
066.23



built-up
max. 10kg

067/.. - ROSETTE HOOK

~230V  IP20   



Accessories for pendant lamps - square - built-up rosette with closed hook for suspension

Dimensions

↔ L70xB70xH40 mm ↗ L60xB60 mm

Materials

Aluminium 1M | 2M | 14
Aluminium / Messing 42 | 162 | 232 | 132

Ref

067.1M
067.2M
067.42
067.14
067.232
067.132
067.162



built-up

068/.. - ROSETTE HOOK

~230V  IP20    0.3900 



Accessories for pendant lamps - square - built-up rosette with open hook for suspension

Dimensions

↔ L80xB80xH40 mm ↗ L70xB70 mm

Materials

Aluminium 1M | 2M | 14
Aluminium / Messing 42 | 162 | 232 | 132

Ref

068.1M
068.2M
068.42
068.14
068.232
068.132
068.162



built-up

069/.. - ROSETTE HOOK

 IP20    0.3200 



built-up base - built-up rosette with closed hook for suspension

Dimensions

↔ L70xB70xH40 mm

Materials

Inox 304 32X | 53X | 46X

Ref

069.32X
069.46X
069.53X



built-up

070/.. - ROSETTE HOOK

IP20    CE



built-up base - built-up rosette with open hook for suspension

Dimensions

↳ L70xB70xH40 mm

Materials

Inox 304 32X | 53X | 46X

Ref

070.32X ●
070.46X ●
070.53X ●

built-up

1623/.. - ROSETTE HOOK

IP20   CE



Accessories for pendant lamps - built-up rosette with open hook for suspension

Dimensions

↳ Ø65xH58 mm



Materials

Aluminium 1 | 1M | 2 | 2M | 11
Messing 4 | 16 | 13 | 23 | 97

Ref

1623.1 ●
1623.1M ●
1623.2 ●
1623.2M ●
1623.11 ●
1623.4 ●
1623.16 ●
1623.13 ●
1623.23 ●
1623.97 ●

062/.. - ROSETTE for chain

IP20    CE



built-up base - built-up rosette for chain polo

Dimensions

↳ L70xB70xH75 mm coverplate L70xB70 mm

↳ L65xB65xH43 mm

Materials

Inox 31MX | 32X | 37X | 46X
Inox 316 5 | 5BB

Ref

062.5 ●
062.5BB ●
062.31MX ●
062.32X ●
062.37X ●
062.46X ●

built-up

063/.. - ROSETTE UP

IP20    CE

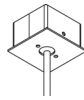

built-up base - built-up rosette B3 for rod Ø12mm

Dimensions

 L70xB70xH43 mm coverplate L70xB70 mm

 L60xB60xH43 mm

Materials

Inox 31MX | 32X | 37X | 46X

Inox 316 5 | 5B

Ref

063.5

063.5B

063.31MX

063.32X

063.37X

063.46X



built-up



ACCESSORIES

ROSETTE UP

1700/.. - BETAPLUS

IP20   



built-up base - square - place for driver

Dimensions

↳ L90xB90xH110 mm

Materials

Aluminium 1M | 2M | 11M | 104 | 29

Options

- P040/.. STRAIN RELIEF - TREKONTLASTING
- P039/.. STRAIN RELIEF - TREKONTLASTING
- P038/.. STRAIN RELIEF - TREKONTLASTING

Ref

- 1700.1M
- 1700.2M
- 1700.11M
- 1700.104
- 1700.29



built-up

Colours indoor



Colours indoor special



Colours outdoor



ACCESSORIES

ROSETTE UP



Groendreef 60, 9880 Aalter | T +32 9 374 19 51 | www.psmlighting.be

All our products are locally made in Aalter, Belgium (EU). Short delivery times.